

Compex 450mm 304 Stainless Steel Drawer Slides

PART No: GT013145

FEATURES

Compex 304 Grade Stainless Steel Telescopic Drawer Slides with 60mm longer work - run.

Length - 450mm

Work-Run - 510mm

Total Length - 960mm

Fully Extended Weight Rating - 50kg

Made in Italy these high quality stainless steel drawer slides with Acetal Homopolymer Resin Rollers have a smooth strong action and are ideal for the Foodservice and Commercial Refrigeration industries. Acetal Homopolymer Resin is a highly crystalline polymer that has high stiffness & strength without the need for glass reinforcement. Fastening to your cabinet can be easily achieved with screws or rivets.

Colour: Stainless Steel Brilliant Finish

Material: 304 Grade Stainless Steel with Acetalic Rollers

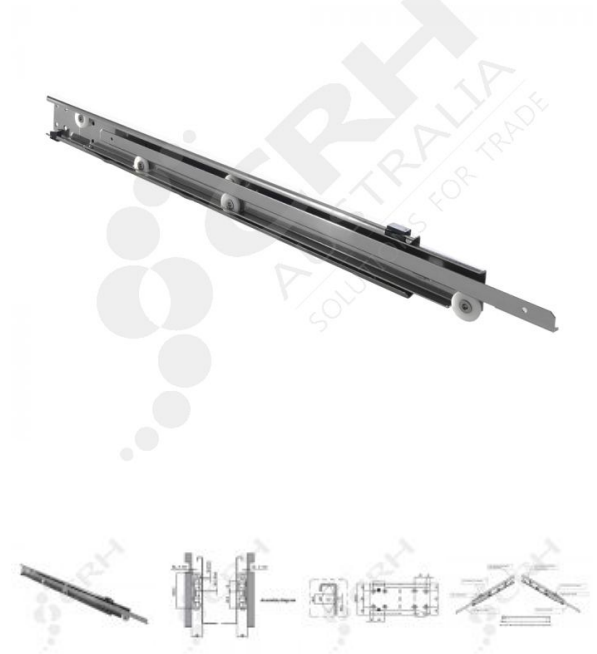

CRH Australia Pty Ltd 1-3 Nelson Street Moorabbin VIC 3189 Australia t+61 3 9532 f+61 3 9532 2696



info@crh.com.au

www.crh.com.au